

The General Radio Experimenter

VOL. V, No. 4

SEPTEMBER, 1930

ELECTRICALLY-DRIVEN TUNING FORKS

By HORATIO W. LAMSON*

SUMMARY — The choice of a particular type of tuning fork depends largely upon the requirements of the problem at hand and upon the degree of frequency stability desired. Simplest and least precise are the contact-driven forks which, however, are capable of supplying considerable power output of approximately square-top waveform. When a sinusoidal output of good precision is desired, as, for instance, in the case of a tone source for bridge measurements, the single microphone drive serves admirably well. Still greater precision, more power, and purer waveform are to be had from the somewhat more complicated double-button fork. A high-precision standard demands the use of a freely vibrating fork, such as is exemplified by the vacuum-tube-driven type. The ultimate in precision so far attained is to be found in the freely vibrating fork with suitable provision for eliminating its temperature error.

ANY simple vibrating mechanical system possesses a definite and constant period of vibration. Such a system may be used either as a standard of frequency or as a standard of time, if all of the individual factors governing the frequency of the system remain constant. These factors are, principally, the physical dimensions of the system and the amplitude and decrement of its vibration.

Consider, for example, the simple pendulum. Its frequency is inversely proportional to the square root of its length and decreases slightly with an increase in amplitude of vibration. This amplitude error is due to the fact that when the pendulum is displaced, the restoring force, gravity, is no longer parallel to the line between the point of support and the center of the bob. The error increases proportionately with amplitude.

If the pendulum bob is displaced and

* Engineer, General Radio Company.

allowed to swing freely, it will execute a damped vibration. The frequency will continuously increase until it finally comes to rest. The less the damping, the less the amplitude change per cycle, and the more nearly constant will be the instantaneous value of the frequency. If we wish to maintain constant amplitude, we must effectively eliminate the damping by supplying the pendulum continuously or at uniform intervals with a sufficient amount of energy to offset all of the losses. This is accomplished in the ordinary clock by means of the spring-driven escapement mechanism.

The essential features for constant frequency of the pendulum are, therefore: (1) constant mechanical dimensions, (2) minimum amplitude of vibration, (3) minimum damping of vibration, (4) reception of sufficient power at each cycle from an external source to overcome damping.

The tuning fork is likewise a vibrat-

ing system subject to the same fundamental laws of frequency control. It consists usually of a U-shaped bar having a rectangular cross-section. When vibrating in its fundamental manner, the ends of the tines possess a maximum motion transverse to their length and in the plane of the fork. This transverse motion decreases continuously along the tines and becomes zero at the heel of the fork where the vibration occurs in a direction along the tines, because as the tines vibrate, their center of gravity is moved slightly to and fro in a direction along the tines with a frequency equal to twice that of the fork. In the tuning fork the amplitude error is due to the fact that when the tine is deflected the restoring force is not perpendicular to the axis of the tine.

In addition to the four requirements for constancy in the pendulum, the fork requires another: (5) The two tines must be exact mechanical duplicates and have equal amplitudes and damping.

Tuning forks have been used for many years as standards of pitch. The frequency is approximately inversely proportional to the square of the length of the tines and roughly proportional to the thickness of the tines in the plane of vibration. The dimension of the tines perpendicular to the plane of vibration has practically no effect upon the frequency. When used as a standard of musical pitch, a fork is ordinarily struck a single blow and allowed to execute a damped vibration. The slight change in frequency during damping is negligible from a musician's standpoint.

If, however, the tuning fork is to be used as a high-precision standard of frequency, it must obviously receive continuous excitation from an external source. Such excitation might be purely mechanical in nature, analogous to the escapement of a clock, but the form and

motion of the tuning fork renders it particularly favorable to magnetic excitation, if the fork is constructed of magnetic material and is subjected to a series of magnetic pulses approximating the natural frequency of the fork. If, furthermore, these energizing pulses are in some manner synchronized by the motion of the fork itself, then the fork will become oscillatory at its natural frequency. We propose to discuss various methods by which this self-synchronized energizing of the fork may be accomplished.

A tuning fork intended to be used as a frequency standard would not be designed to furnish directly any great amount of acoustic energy since to do so would necessarily increase its damping. Obviously, if the fork is to be electrically driven an unlimited acoustic output may be obtained indirectly by means of vacuum-tube amplification.

In passing it may be noted that the frequency of all types of forks may be initially calibrated to a predetermined value by grinding the free ends of the tines. The natural frequency of a fork may be varied by means of adjustable weights on the tines. Great care must be exercised, however, to keep the tines symmetrically loaded. Loading is not to be recommended for forks of the highest precision.

Contact Drive — The earliest attempt at self-synchronized electrical driving of the tuning fork followed the principle of the ordinary electric bell or buzzer, and constituted the so-called contact-driven fork. Figure 1 shows a schematic diagram and Figure 2 a photograph of a fork of this type. Each tine of the fork is attracted outwardly by an electromagnet *D*. One tine of the fork carries a flexible spring *O* which makes contact with a stationary adjustable contact point *P* during a portion of the cycle when the tines of the fork are bent inward. This contact closes the battery circuit through the magnets

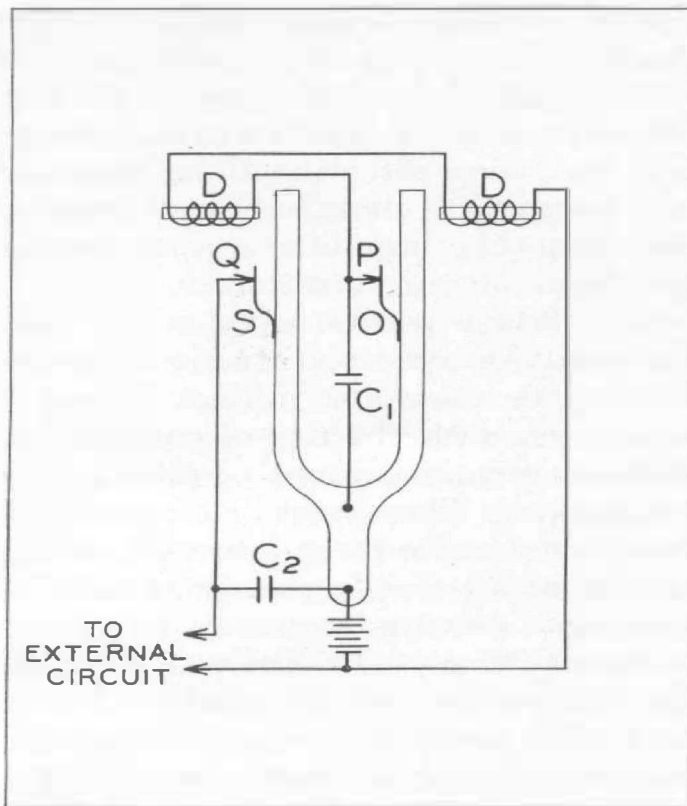

FIGURE 1. A contact-driven fork (schematic)

D, thus energizing them and drawing the prongs outward, which in turn serves to break the contact and deenergize the magnets. The released prongs then spring inward by virtue of their elasticity, thus reestablishing electrical contact between *P* and *O*. This cycle is, of course, repeated with the frequency of the fork. The energy necessary to overcome the damping of the fork consists of the magnetic pulses imparted at each cycle of the tines and comes from an external source, the battery. The amplitude of vibration of the tines depends, among other things, upon the duration of the energizing pulses, that is, the duration of the contact between *P* and *O*. If this interval is less than one-half of one cycle, the amplitude may be kept relatively low, but the fork cannot be self-starting.

One of the principal uses of the tuning-fork standard is to supply a pulsating or an alternating current having a standardized frequency equal to that

of the fork, or some integral multiple or sub-multiple thereof. By adding a second contact point and springs *Q* and *S*, interrupted current may be supplied to an external circuit in the manner shown. The relative duration of the off and on periods are controlled by the adjustment of *Q* with respect to *S*. Frequently, two contact points *Q* are supplied, one on each side of *S*. Such an arrangement gives an interrupted current having twice the frequency of the fork. The two condensers *C*₁ and *C*₂ are for the purpose of suppressing sparking at the contact points.

The contact-driven fork provides a simple and moderately precise standard. If it is necessary to deliver relatively large amounts of energy directly

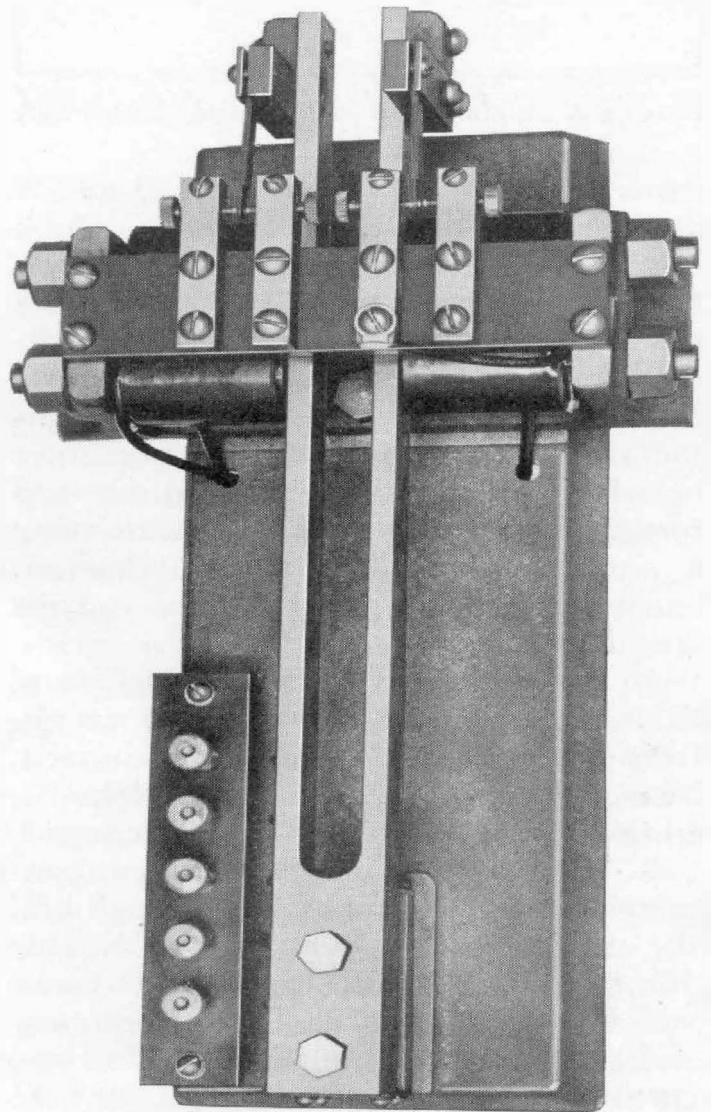

FIGURE 2. A contact-driven fork

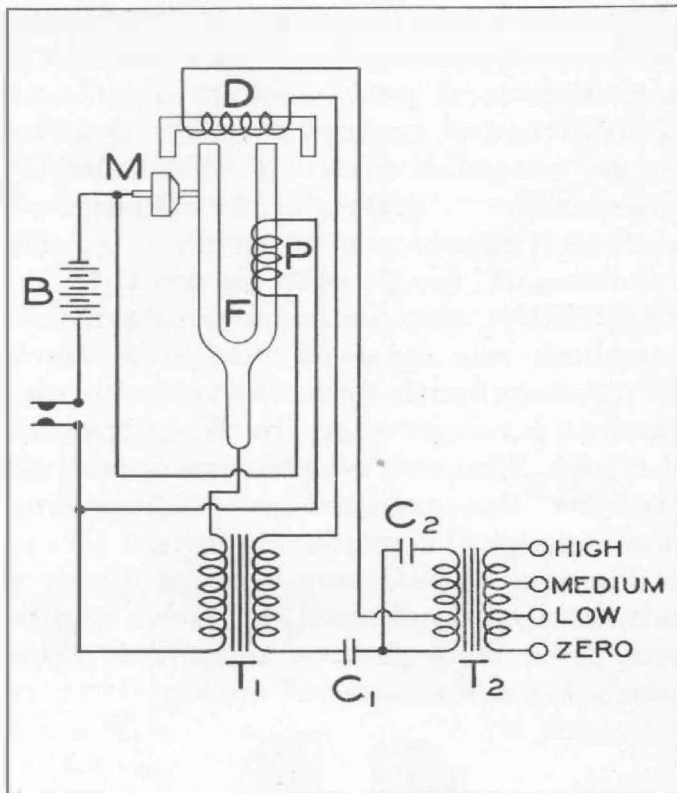

FIGURE 3. Single-button microphone-driven fork

from a fork, the two contacts *Q* and *S* are required, and therefore such a fork might as well be of the contact-driven type. This type has, however, some inherent defects which seriously handicap its use as a high-precision standard:

1. With a proper design of the contacts, the output-current wave may closely approximate the square-top form. If anything even approximating a simple sinusoidal wave is desired, considerable doctoring of the output circuits is necessary.

2. To obtain a satisfactory action of the contacts, a relatively large amplitude of vibration of the tines is required. This, we have seen, is not conducive to the highest precision of frequency.

3. The intermittent mechanical contact between the vibrating springs and the stationary points adds considerable damping to the motion of the tines, which likewise lowers the frequency stability. If the damping of the two tines becomes unsymmetrical due to inequality of the contact adjustments,

further complications arise which make the fork less stable in its operation.

4. Minute physical changes in the contact members due to wearing, heating, etc., may alter the time intervals of magnetic energization, thereby changing the amplitude, and hence the frequency of vibration.

5. Contact points, even when well designed, are apt to be erratic in operation, since they are subject to wear, and, even with the use of condensers, suffer a certain amount of pitting due to sparking. They must be cleaned and readjusted at frequent intervals, which results in a possible change of adjustment and driving frequency.

Single-Microphone Drive — Some of the difficulties of the contact-driven fork are partially overcome in the microphone-driven fork shown schematically in Figure 3 and pictorially in Figure 4. On one tine of the fork is mounted one electrode of a carbon-button microphone *M*; the other electrode, being an integral part of the housing shell, is supported through a spring within a stationary protective metallic cup. Any vibration of the tines will jar the microphone and thus cause a synchronous fluctuation of the bat-

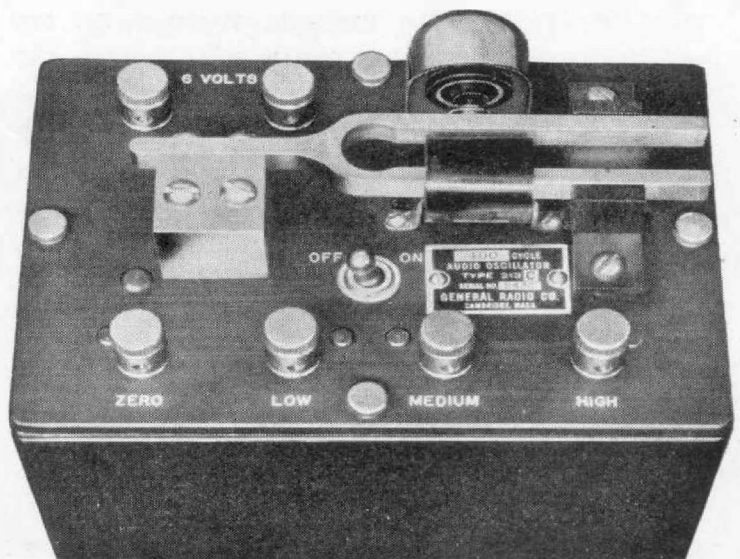

FIGURE 4. General Radio TYPE 213-C 400-cycle Audio Oscillator, a typical single-button microphone-driven fork

tery current through it and the primary of the transformer T_1 . The secondary current from this transformer passes through a condenser C_1 , a portion of the primary of the transformer T_2 , and the driving coil D , so that the latter will supply magnetic pulses to the fork to compensate for its damping losses, thus maintaining a continuous vibration at some fixed amplitude and frequency. The condenser C_1 serves to obtain the proper phase relation between the driving current and the synchronous vibration of the microphone. The whole of the primary of T_2 is tuned electrically by means of the condenser C_2 to the natural frequency of the fork, thereby purifying the output waveform. A tapped secondary of T_2 enables various output voltages to be obtained. In order to prevent the tines from being energized at double frequency, they are magnetically polarized by a steady current from the battery passing through a shunt circuit comprising the coil P which surrounds one tine of the fork.*

This fork is free from contact troubles and may be operated with a much smaller and more constant amplitude and decrement and has, therefore, a more nearly constant frequency than the contact-driven fork. Furthermore,

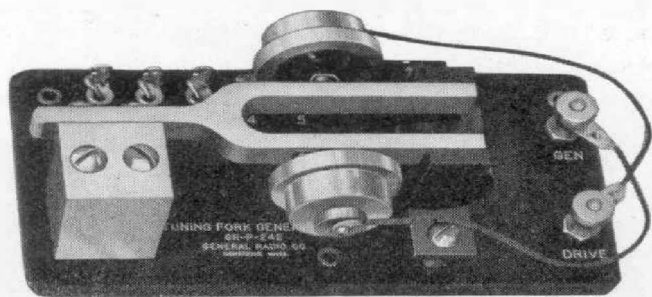

FIGURE 5. A double-button microphone-driven fork. Note the heavy brass inertia caps which house the microphone buttons

* This is the system used in General Radio TYPE 213 Audio Oscillators, a more extensive analysis of which will be found in an article by Charles E. Worthen, "A Tuning-Fork Audio Oscillator," *General Radio Experimenter*, IV, 11, April, 1930.

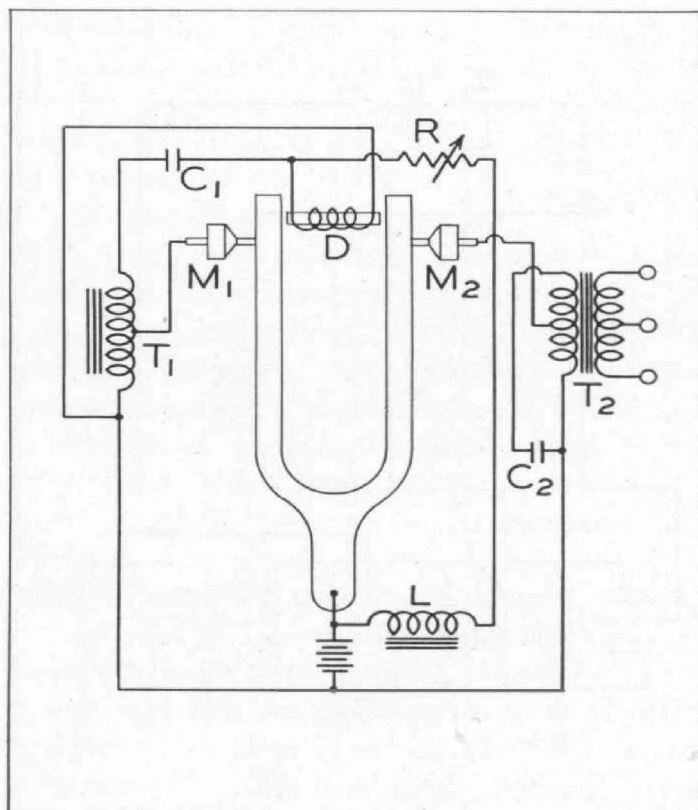

FIGURE 6. A double-button microphone-driven fork

it is capable of supplying directly a sinusoidal electrical output in which the harmonic content does not exceed 8 per cent. of the fundamental for ordinary resistive loads. However, owing to the fact that the total available output of the single-microphone button must be divided between the driving coil and the output load, the available output power is necessarily limited to about 50 milliwatts.

Double-Microphone Drive — In order to increase the available output, it is quite practicable to mount a microphone on each tine of the fork, giving the double-button type (see Figures 5 and 6). Battery current passes through the driving microphone M_1 and a portion of the auto-transformer, T_1 . The full output of this transformer passes through the condenser C_1 and the driving coil D which energizes the tines in synchronism with their natural frequency and thus supplies the energy to overcome all damping. C_1 serves the dual purpose of properly

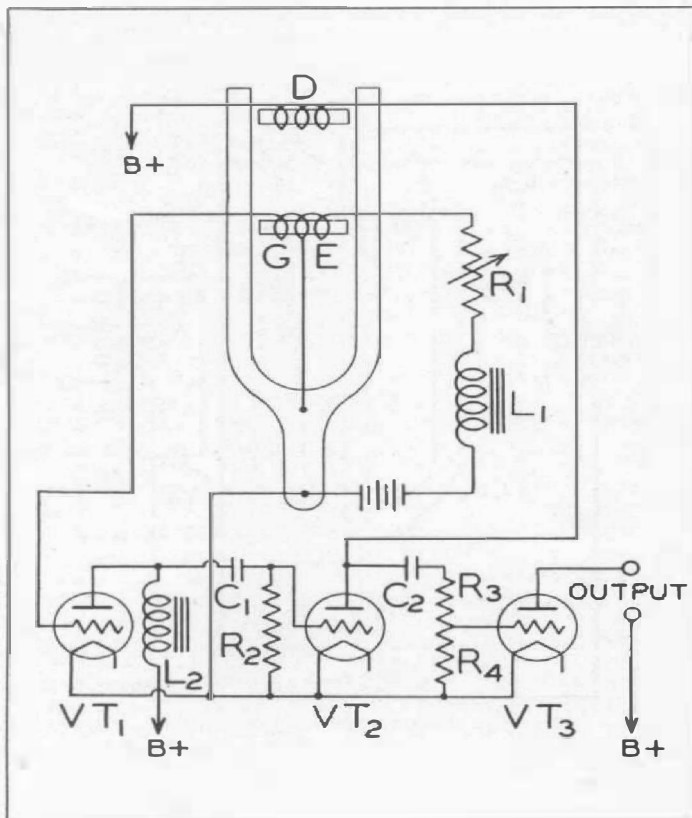

FIGURE 7. A schematic diagram for a vacuum-tube-driven fork

phasing the driving current and providing a blocking condenser for direct-current potential. The necessary polarizing current passes through the same winding D and the choke L and may be adjusted to the proper magnitude by means of the resistance R . The output microphone M_2 is energized by the same battery and feeds the output circuit through transformer T_2 having a tuned primary and a tapped secondary, as previously described.

Obviously, this arrangement is capable of delivering considerably more power than the single-button type. It possesses another distinct advantage in that both tines of the fork are symmetrically loaded and damped. This gives a purer wave and one more stable in power output and frequency. In order to further enhance the symmetry of the tines, the microphones are not supported from the rear through springs which are difficult to adjust and maintain as exact mechani-

cal duplicates. Instead, inertia-type microphones are used suspended wholly from the tines, electric contact being obtained through light pigtail connectors of negligible mechanical effect. To improve this inertia action, the microphones are loaded with carefully designed inertia caps seen in the photograph.

Vacuum-Tube Drive — The double-button fork achieves many of the five enumerated requirements for a precision tuning-fork standard. Owing, however, to unavoidable variations in the stiffness and reaction of the diaphragm of the microphone buttons, as well as small shifts in their center of gravity due to the loose carbon granules, perfect symmetry in the loading and damping of the tines cannot be maintained.

The obvious solution of this difficulty would be to employ a system in which the tines of the fork are unloaded, fashioned in a simple form with extreme

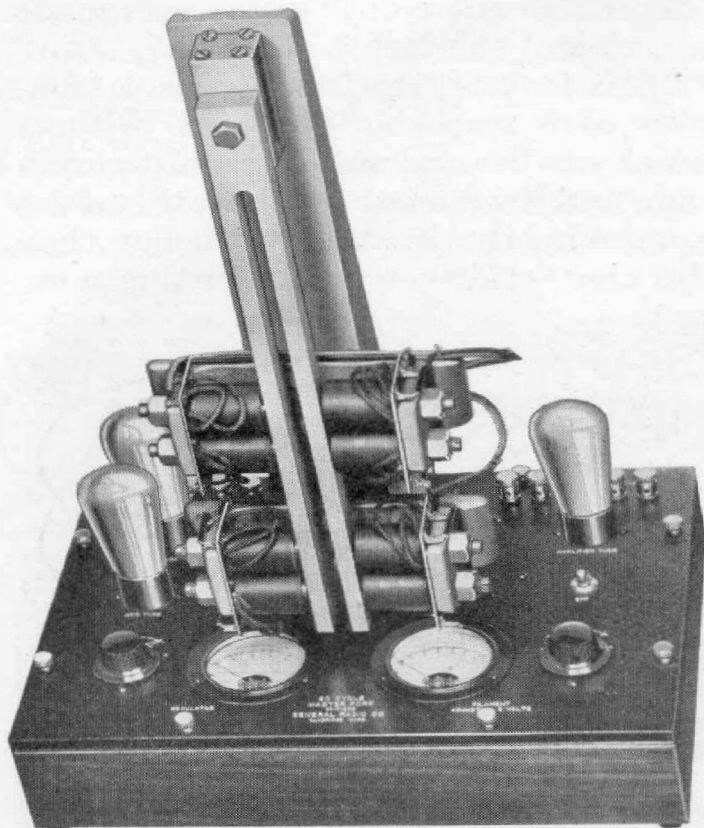

FIGURE 8. A 60-cycle vacuum-tube-driven tuning fork. The two lower pairs of magnets are the drivers

precision, and allowed to vibrate without any physical contact. These conditions are attained in the vacuum-tube-driven tuning fork. The fundamental principles of one method for driving such a fork are indicated in the schematic diagram (see Figure 7).

Vibration of the tines induces a potential in the "grid" winding G which is suitably polarized by a winding E , the latter being in a circuit comprising a battery, a choke L_1 , and an adjustable resistance R_1 . The potentials thus induced in G are applied to the grid of a vacuum tube VT_1 , known as the "grid" tube, which, in turn, is coupled to a second tube VT_2 by the elements L_2 , C_1 , and R_2 . The output of the "drive" tube VT_2 is consumed in the driving coil D which energizes the fork and maintains it in

vibration. It will be noted that this driving current (and hence the magnetic pulses) are polarized also, i.e., are pulsating rather than alternating in character.

Although not apparent in the drawing, the two separate windings D and GE are so arranged that there is no magnetic coupling between them. We have, therefore, a regenerative amplifier system in which the feedback agent consists of the mechanical motion of the tines. The latter being entirely free, the fork vibrates at a frequency very close to its natural period and provides thus a high-precision standard.

The adjustment of the parts and the operating parameters of the tubes may vary the amplitude and hence the frequency of the fork to a very slight degree. Proper manipulation of these controls enables the precise adjustment of the frequency to some predetermined value with a much greater precision than can readily be attained by grinding the ends of the tines.

In order to realize a negligible reaction of the output load upon the driving circuits, a small portion of the output voltage of the drive tube VT_2 is applied through members C_2 , R_3 , and R_4 to the grid of one or more amplifier tubes VT_3 .

An example of the vacuum-tube-driven fork is seen in Figure 8. In order to minimize the damping on the fork, a special mounting is provided for the heel which is somewhat elastic in a direction along the tines. This reduces the amount of vibrational energy transmitted to the support base and hence the damping.

A tuning fork of this type has such a high precision that, if the fork is fashioned from homogeneous high-grade tool steel, the greatest source of error ordinarily consists of the temperature coefficient of frequency (due to the elongation of the tines with temperature) which is of the order of one part in 10,000 per degree C. Their precision

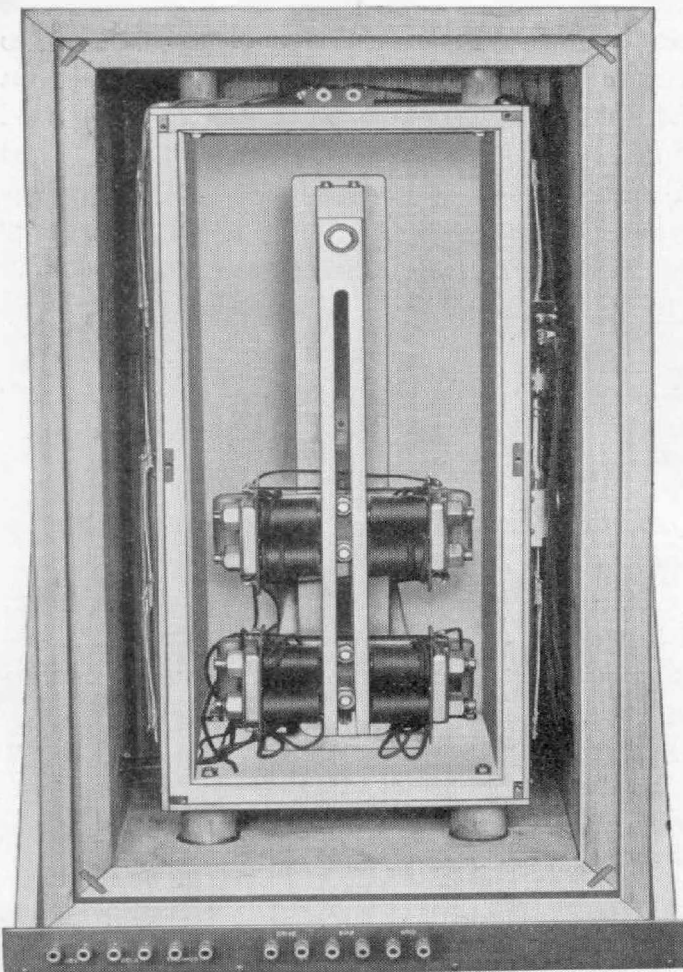

FIGURE 9. A fork similar to that shown in FIGURE 8 mounted in a temperature-controlled compartment

may, therefore, be improved by employing one or both of the following methods:

1. Construct a bimetallic fork, the heel and lower part of the tines being of one material and the outer part of the tines of another material, so chosen and proportioned that the fork, as a whole, possesses a much smaller temperature coefficient.

2. Enclose the fork in a thermostatically-controlled constant-temperature compartment.

An example of the latter procedure is seen in Figure 9. The multi-walled compartment is shown open with the fork unit, similar to Figure 8, located therein.

In this particular arrangement of a temperature-controlled tube-driven fork, the temperature could be kept fixed within 0.1° F., and, as a result, the frequency of the fork could be maintained accurately constant to the order of one part in 100,000. Such a fork was used to drive a synchronous-motor-driven clock so that the fork was actually a time-keeping device. The above-mentioned precision corresponds

to better than one second per day in this time-keeping system.

Other Free-Fork Methods — The high precision obtainable by the use of a freely vibrating fork may be accomplished in other ways, as, for example, by employing an electrostatic rather than an electromagnetic pickup.

A condenser is formed having one stationary electrode and one moving electrode which is the vibrating tines. A steady polarizing potential is applied to this condenser so that a variation in its capacity produces pulsating currents which may be amplified to drive the fork electromagnetically.

The selection of a fork for a particular purpose is somewhat determined by the desired frequency. Forks having from a few cycles up to several hundred cycles per second may readily be contact-driven. Single-button forks have been constructed in the General Radio Company's laboratories covering a range of from 400 to 1500 cycles and double-button forks, from 300 to 2500 cycles. With proper design, vacuum-tube-driven forks may be made to cover at least the audible-frequency range.

MISCELLANY

By THE EDITOR

IN America tuning-fork oscillators have not received the popular attention they deserve, although many foreign investigators believe that tuning forks can be more stable than quartz plates and bars. We feel that there is a field of usefulness for the

tuning fork which should not be overlooked.

All of the illustrations for Mr. Lamson's article are from typical tuning forks which have been built and operated in the laboratories of the General Radio Company.

The General Radio *Experimenter* is published monthly to furnish useful information about the radio and electrical laboratory apparatus manufactured by the General Radio Company. It is sent without charge to interested persons. Requests should be addressed to the

GENERAL RADIO COMPANY
CAMBRIDGE A, MASSACHUSETTS

RUMFORD PRESS
CONCORD, N.H.